









33 845 875



- sporgenza 552 mm
- bocca girevole 360°
- Getto con aria
- altezza rubinetteria 372 mm
- altezza fino al rompigitto 290 mm
- rosetta 55 mm
- diametro foro 30 mm
- portata max 8 l/min a una pressione idraulica di 3 bar
- senza piombo
- Questo prodotto può aiutare un edificio a soddisfare i requisiti dei Green Building Rating Systems, ad es. LEED®, BREEAM®, DGNB

	Platinato spazzolato	33 845 875-06
	Cromato	33 845 875-00
	Platinato	33 845 875-08
	Ottone (Oro 23k)	33 845 875-09
	Dark Chrome	33 845 875-19
	Ottone spazzolato (Oro 23k)	33 845 875-28
	Champagne spazzolato (Oro 22k)	33 845 875-46
	Champagne (Oro 22k)	33 845 875-47
	Cromo spazzolato	33 845 875-93
	Dark Platinum spazzolato	33 845 875-99

Prodotti complementari



Comando piletta ad eccentrico con manopola con manopola - Platinato spazzolato 10 710 970-06

Prodotti complementari



Dispenser con rosetta - Platinato spazzolato 82 444 970-06

33 845 875



Diagramma di portata



Certificati

LGA_28059.

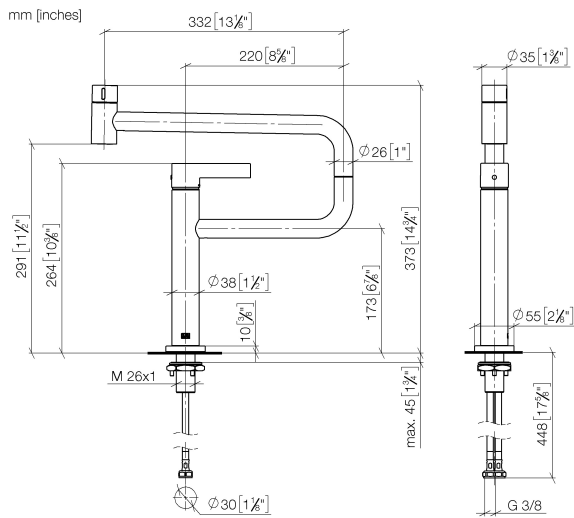
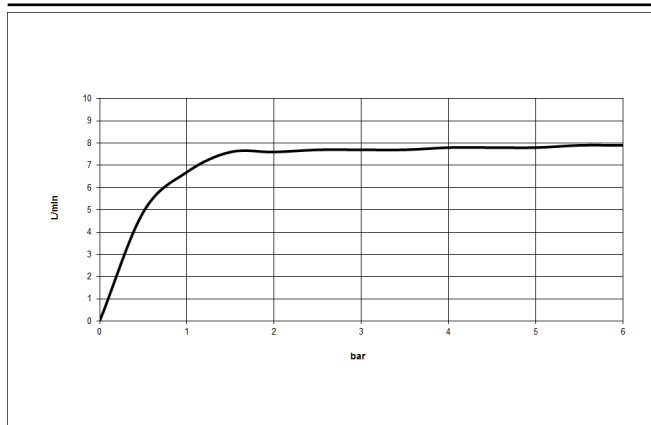
GDV_0400292.

33 845 875

Parts for other finishes can be found here: Cromato

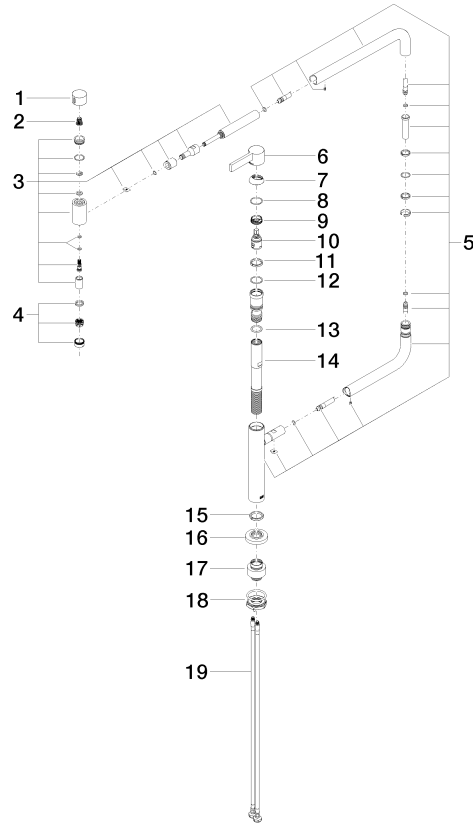

Elenco delle parti di ricambio

N.	Codice articolo	Denominazione	Quantità necessaria	Tempo di produzione
1	09 20 62 025-06	manopola	1	10
2	90 12 12 002 00 90	bussola a scatto	1	2
3	90 19 87 001 00-06	bocca di erogazione	1	10
4	90 23 01 026 07-06	rompigetto	1	10
5	90 28 22 257 00-06	giunto	1	10
6	90 20 87 004 00-06	manopola	1	10
7	09 28 30 013-06	copertura	1	10
8	09 14 10 091 90	guarnizione	1	2
9	09 24 04 266 90	dado	1	2
10	90 15 05 042 00 90	cartuccia	1	2
11	09 28 10 156 90	anello	1	2
12	90 14 10 063 00 90	guarnizione	1	2
13	09 14 10 081 90	guarnizione	1	2
14	09 30 01 126 90	attacco	1	2
15	09 28 10 159 90	anello	1	2
16	09 27 87 033-06	rosetta	1	10
17	12 845 970 90	Set di prolunga -	1	2
18	04 30 11 085 87 90	set di fissaggio	1	2
19	04 30 04 101 00 90	flessibile	2	2